

Gehäuse Oberteil

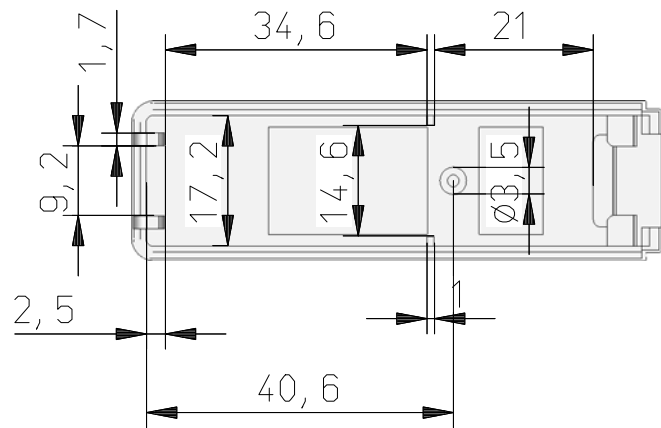
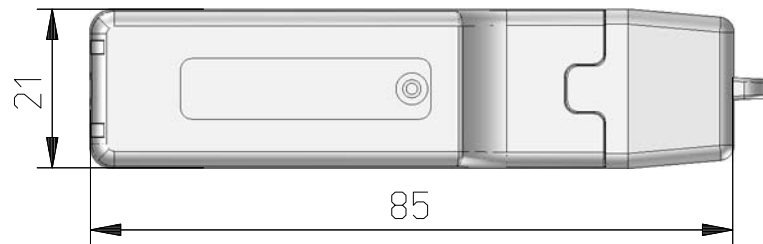
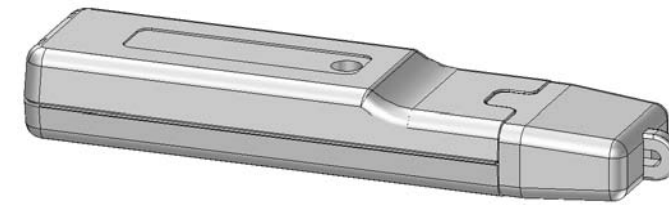
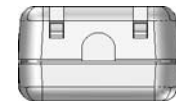
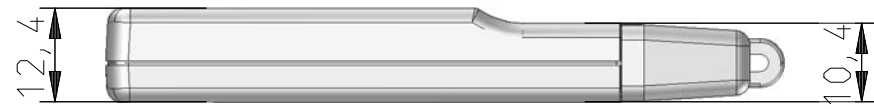
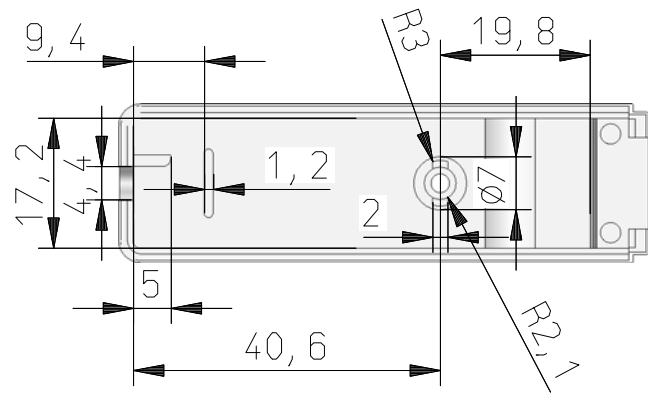

Gehäuse Unterteil

- GH02SG001/605 ABS lichtgrau
- GH02SG001/615 ABS schwarz
- GH02SG001/625 ABS blau
- GH02SG001/635 ABS rot
- GH02SG001/645 ABS gelb
- GH02SG001/655 ABS transparent

PCB Vorschlag

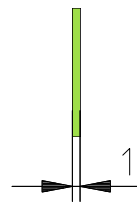
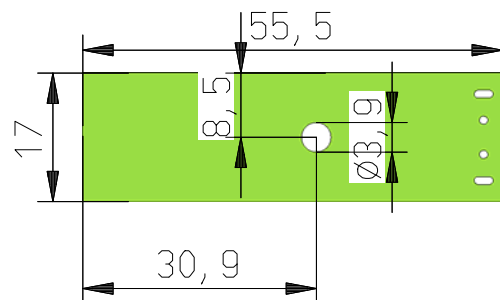

 www.WoehrGmbH.de				Maßstab: 1:1		Gewicht:	
				Schutzvermerk nach DIN 34 beachten / Freimasstoleranzen nach DIN 7168 mittel			
				Datum	Name		
				Bearb.	13.04.2010	A.Schiele	
				Gepr.			
				Norm			
				ab			
				Serie GH02SG001			Blatt 1
				GH02SG001/6X5			
				Material: ABS			Bl. 1
Zust.	Änderung	Datum	Name	Urspr.	Ers. f.:	Ers. d.:	